

# MODEL A PHAETON

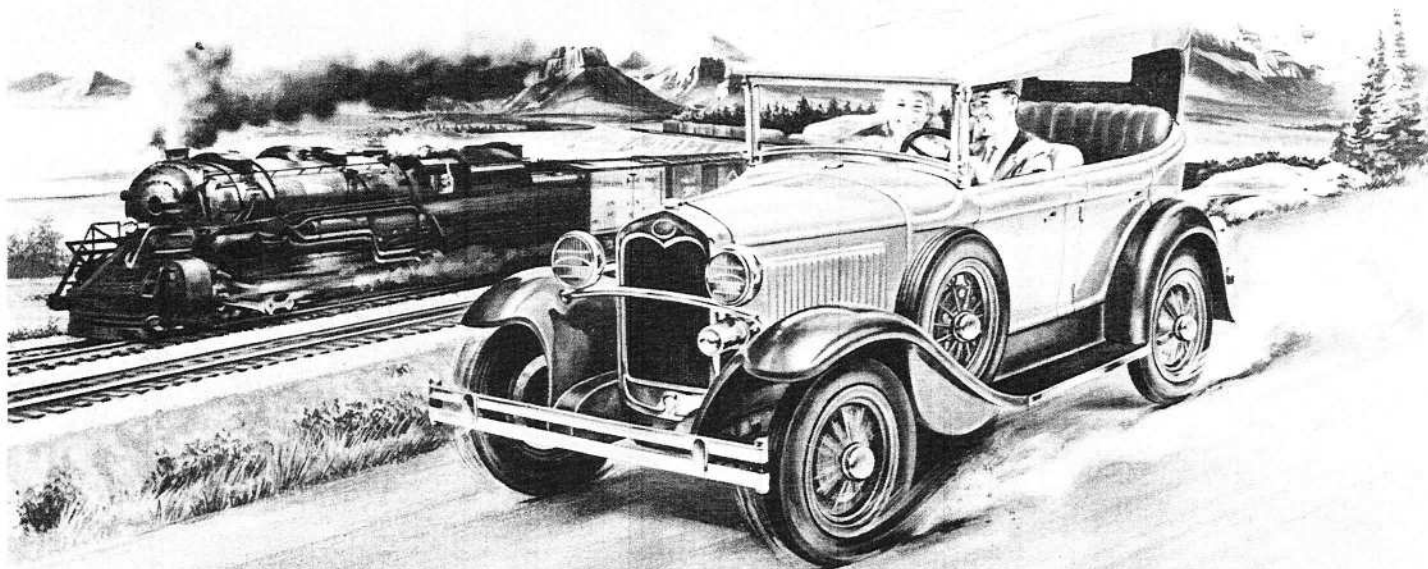

The venerable Model T reached the end of the line on March 26, 1927. Her seemingly imperishable lines had finally revealed her age. While sales were still astronomical, younger competitors were crowding her off the stage.

It was time for a change and Henry Ford knew it. By May 1927, the Model A was out of the planning stage and ready for production. On October 20, 1927, the first engine came down the line. On December 2, the Model A bowed to the public. The planetary transmission was replaced by a standard three-speed shift. The flywheel magneto gave way to coil and battery ignition. There were instruments on the instrument panel and lights to read them by. There was a foot accelerator and, for the first time, safety glass in the windshield. There were shock absorbers, four-wheel mechanical brakes, wire wheels, and a choice of colors.

Model A was, in short, a modern car that would bridge the gap between the T and later V-8. Almost 5,000,000 were sold and many, like the T, are running yet.

The Phaetons were quite popular with police departments and the armed forces. Though normally furnished with semi-

gloss black grained top material, the U. S. Army models were fitted with khaki tops. This type has also been popularized by recent television revival of "cops and robbers" films of the early thirties.

Model A's honest claim to sports car characteristics is well supported by performance. On the hill climb in Reading, Pennsylvania, on October 19, 1956, two Phaetons held their own against the formidable competition of two recognized contemporary sports cars, a Mercer Raceabout and a duPont Speedster. This hill, known as Duryea Drive from the time Charles A. Duryea tested his cars there during 1900 to 1907, rises sharply 800 feet in 2½ miles of roadway, with three hair-pin turns and one s-turn followed by a short straight run to the summit. It is considered a real challenge even to modern sports cars.

Of the original 5,000,000 Model A Fords produced, there are 80,000 registered for daily use in the State of Pennsylvania, and there are an estimated 920,000 registered in the United States.

**IMPORTANT! —BEFORE BEGINNING ASSEMBLY, READ AND UNDERSTAND YOUR INSTRUCTIONS.** Use pliers to break ejection pins from castings. Clean flash from castings with file contained in kit or pen knife. Using screws provided, pre-tap all screw holes. This is done by turning the proper sized screws into the screw holes and then removing them again. (Screws will drive more easily if they are first rubbed on a bar of soap.)

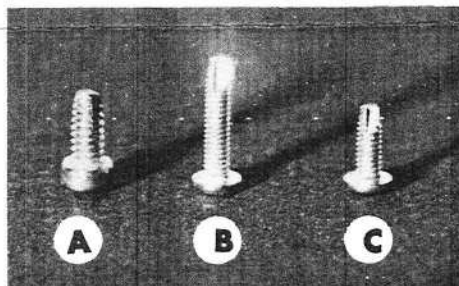
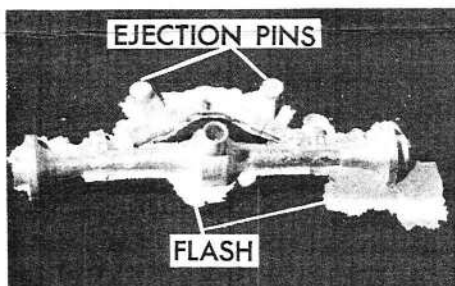

READ AND UNDERSTAND YOUR INSTRUCTIONS.

1. Slide tire (1) on to wheel (2).

2. Attach two wheels to rear end assembly using screw (A), so that lug nuts face out. Insert drive shaft (3) into rear end assembly (3a).

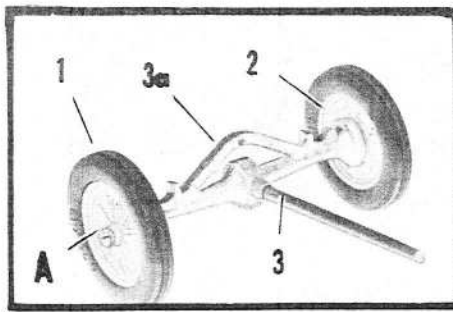

STEP No. 2

3. Attach wheel drums (4) (5) to front axle and spring assembly (6) using screw (B), so that boss on front axle faces forward. Assemble tie rod (7) to wheel drums using two screws (C). Fasten two wheels to front wheel drums with screws (A).

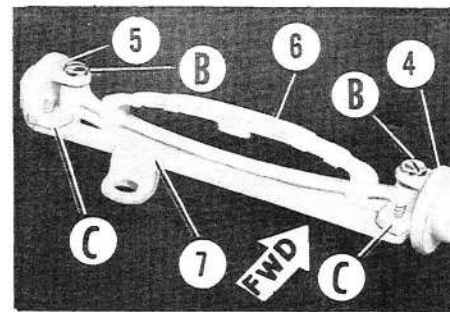

STEP No. 3

4. Place gear shift (8) in slot provided on left side of engine block (9). Place right half of engine (10) on top. Insert engine head (11) in slot on top of block. Secure entire engine assembly with screw (C). Attach fan (12).

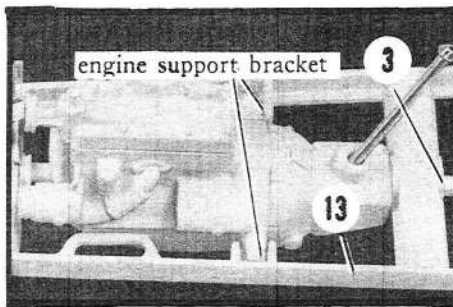

STEP No. 5

5. Rest engine on engine support brackets. Insert drive shaft into rear of transmission. Spring of rear end assembly slides into spring housing and is secured to frame (13) with screw (C).

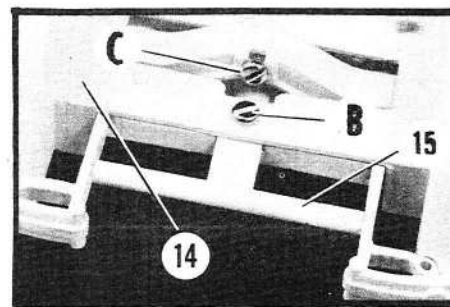

STEP Nos. 5 & 6

6. Drop chassis (14) in position on top of frame. Insert rear bumper (15) in slots provided. Secure with screw (B). Insert front end assembly into spring housing with tie rod toward rear of car. Place radiator (16) in front of front spring housing. Attach radiator and front end assembly to frame with screw (C). Attach hose (17) to radiator.

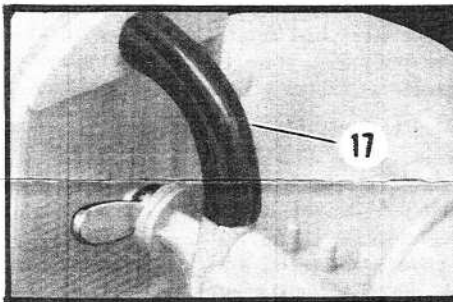

STEP No. 6

7. Press two halves of body (18) (19) together and secure with screw (C) through spark coil. Press steering wheel (20) onto steering column (21). Insert steering column through dashboard (22) and tie rod. Attach dashboard to body with screw (C) through fire wall. Attach body to frame with two screws (B).

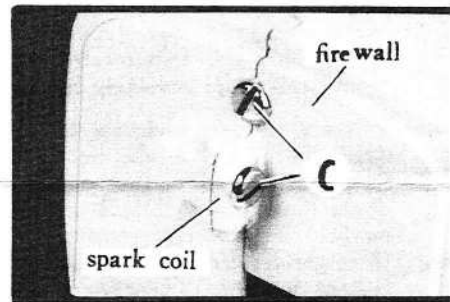

STEP No. 7

8. Drop front and rear seats (23) (24) into position and fasten from underneath with screw (C). Slide two halves of hood (25) (26) together and place in position.

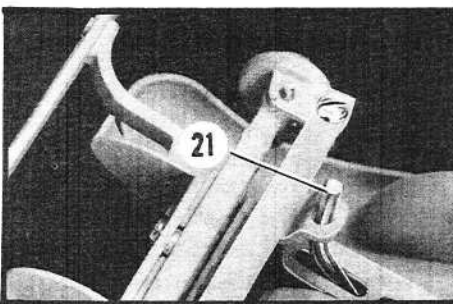

STEP No. 7

9. Cement tail light (27) into rear of rear fenders.

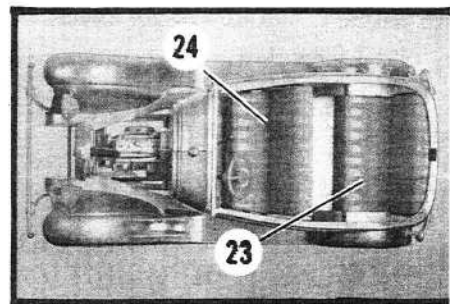

STEP No. 8

10. Press lenses (28) into headlight (29). Press headlight assembly into holes in front fenders.

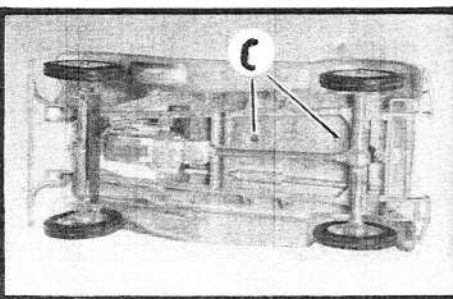

STEP No. 8

11. Attach top (30).

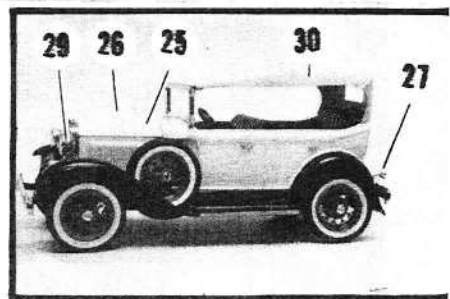

STEP Nos. 8, 9, 10 & 11

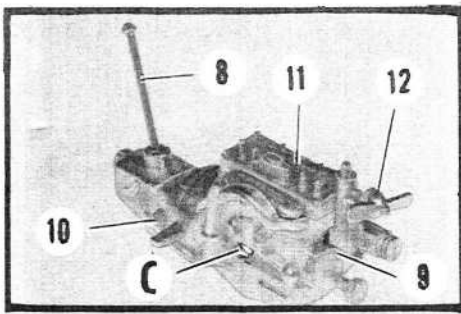

STEP No. 4

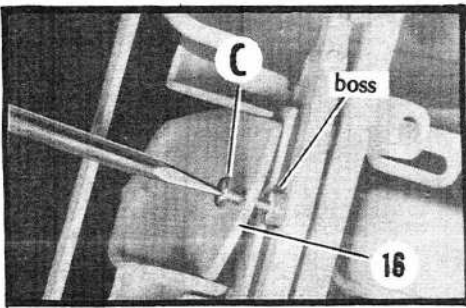

STEP No. 6

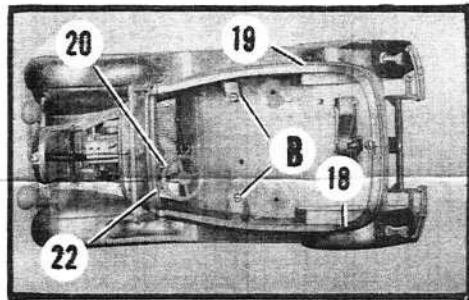

STEP No. 7

If any parts should be missing, circle missing parts on parts list, cut out coupon, print name and address on other side, and mail to:

THE HUBLEY MANUFACTURING COMPANY  
SCALE MODEL DIVISION  
P. O. BOX 1543, LANCASTER, PA.

### 856K Parts List

- |                                 |                        |
|---------------------------------|------------------------|
| 1. Tire 1 2 3 4 5               | 19. Body, Right        |
| 2. Wheel 1 2 3 4 5              | 20. Steering Wheel     |
| 3. Drive Shaft                  | 21. Steering Column    |
| 3a Rear End                     | 22. Dashboard          |
| 4. Wheel Drum, Right            | 23. Rear Seat          |
| 5. Wheel Drum, Left             | 24. Front Seat         |
| 6. Front Axle & Spring Assembly | 25. Hood, Left         |
| 7. Tie Rod                      | 26. Hood, Right        |
| 8. Gear Shift Lever             | 27. Tail Light 1 2     |
| 9. Engine Block, Left           | 29. Headlight Assembly |
| 10. Engine Block, Right         | 30. Top                |
| 11. Engine Head                 | 31. Screws A, B, C     |
| 12. Fan                         | 32. Decal              |
| 13. Frame                       | 33. File               |
| 14. Chassis                     |                        |
| 15. Rear Bumper                 |                        |
| 16. Radiator                    |                        |
| 17. Radiator Hose               |                        |
| 18. Body, Left                  |                        |

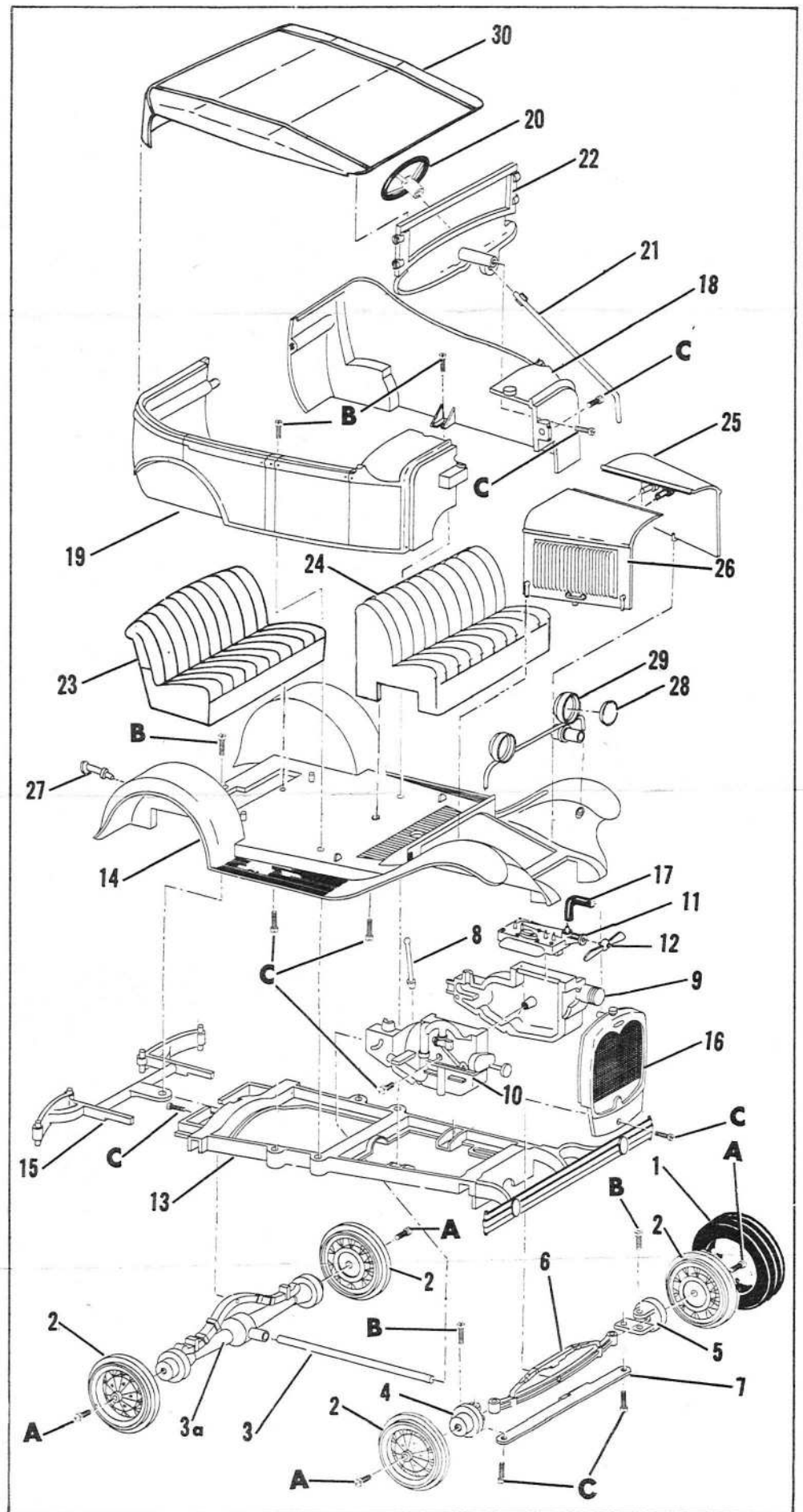

# MODEL A kits by Hubley®

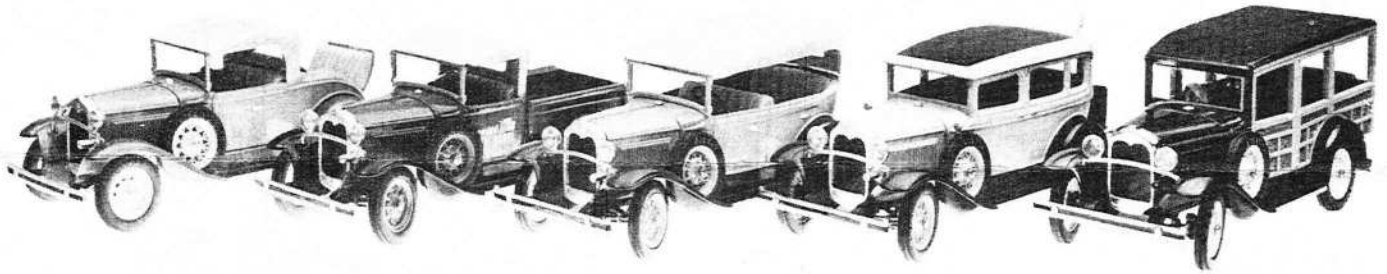

In order to achieve an outstanding and authentic finish on your Hubley Metal Kit, the following steps are suggested:

1. All parts should be thoroughly cleaned and any loose metal dust removed.
2. Rub lightly with fine steel wool or Flex-i-grit reuseable sandpaper, (available at your Hobby store), until smooth.
3. Apply two or three coats of lacquer or enamel in the color desired, rubbing lightly between coats with fine steel wool. Enamel is recommended for hand brushing, but both lacquer and enamel are available in pressure spray cans at your hobby dealer. Wood part of body should be light tan.
4. **CAUTION**—Do not paint plastic parts with lacquer. This will cause wrinkling or crazing of the smooth surface.
5. To achieve a shiny finish on the chrome parts, any of the following methods may be used:
  - a. Buff parts with buffing wheel and then nickel or chrome plate.
  - b. Paint with aluminum enamel.
  - c. Polish with jewelers' rouge, buff, and then apply a coat of clear lacquer.

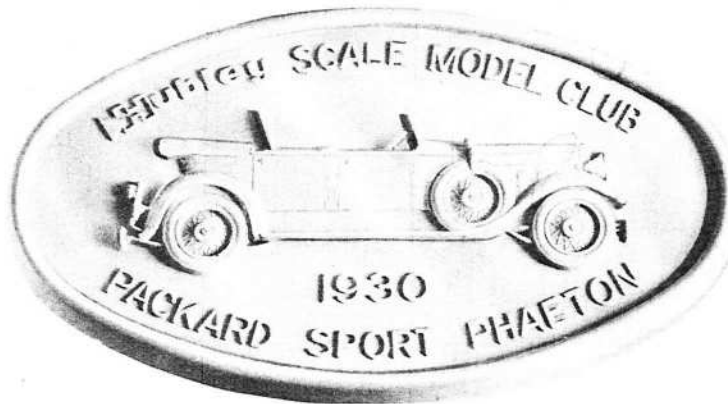

## JOIN THE HUBLEY SCALE MODEL CLUB

Here's the deal! You will receive a 3 $\frac{3}{4}$ " chrome-plated, die-cast metal medallion (See photo above) for use as a wall plaque, paper weight, or bike plate. Also, you will receive a membership certificate, suitable for framing, and a set of multi-colored customizing decals. The Hubley Scale Model Club Newsletter, containing customizing tips for both plastic and metal kits, plus information, news and photos from other members, will be mailed to you as published. Send 50c (in coin) and end panel showing Stock No. from any Hubley Metal Kit box to JACK TEMPLE, c/o THE HUBLEY SCALE MODEL CLUB, BOX 1543, LANCASTER, PENNSYLVANIA.

Send 50c (in coin) and end panel showing  
Stock No. from any Hubley Metal Kit box to  
JACK TEMPLE  
c/o THE HUBLEY SCALE MODEL CLUB   
BOX 1543, LANCASTER, PENNA.

If you wish to become a member check here

(Print Plainly)

NAME \_\_\_\_\_ AGE \_\_\_\_\_

ADDRESS \_\_\_\_\_

CITY & STATE \_\_\_\_\_

INSPECTED BY

